



NOT LEGAL FOR SALE OR USE ON ANY POLLUTION CONTROLLED MOTOR VEHICLE IN CALIFORNIA OR STATES ADOPTING CALIFORNIA EMISSION PROCEDURES.
See knfilters.com for CARB status on each part for a specific vehicle

INSTALLATION INSTRUCTIONS

77-1567KS
JEEP
2012-15 Grand Cherokee SRT8
V8-6.4L

NOTE: This kit was not designed to fit vehicles with a body lift.

TOOLS NEEDED:

- ratchet
- extension
- 10mm socket
- 10mm wrench
- flat blade screw driver
- 4mm allen key

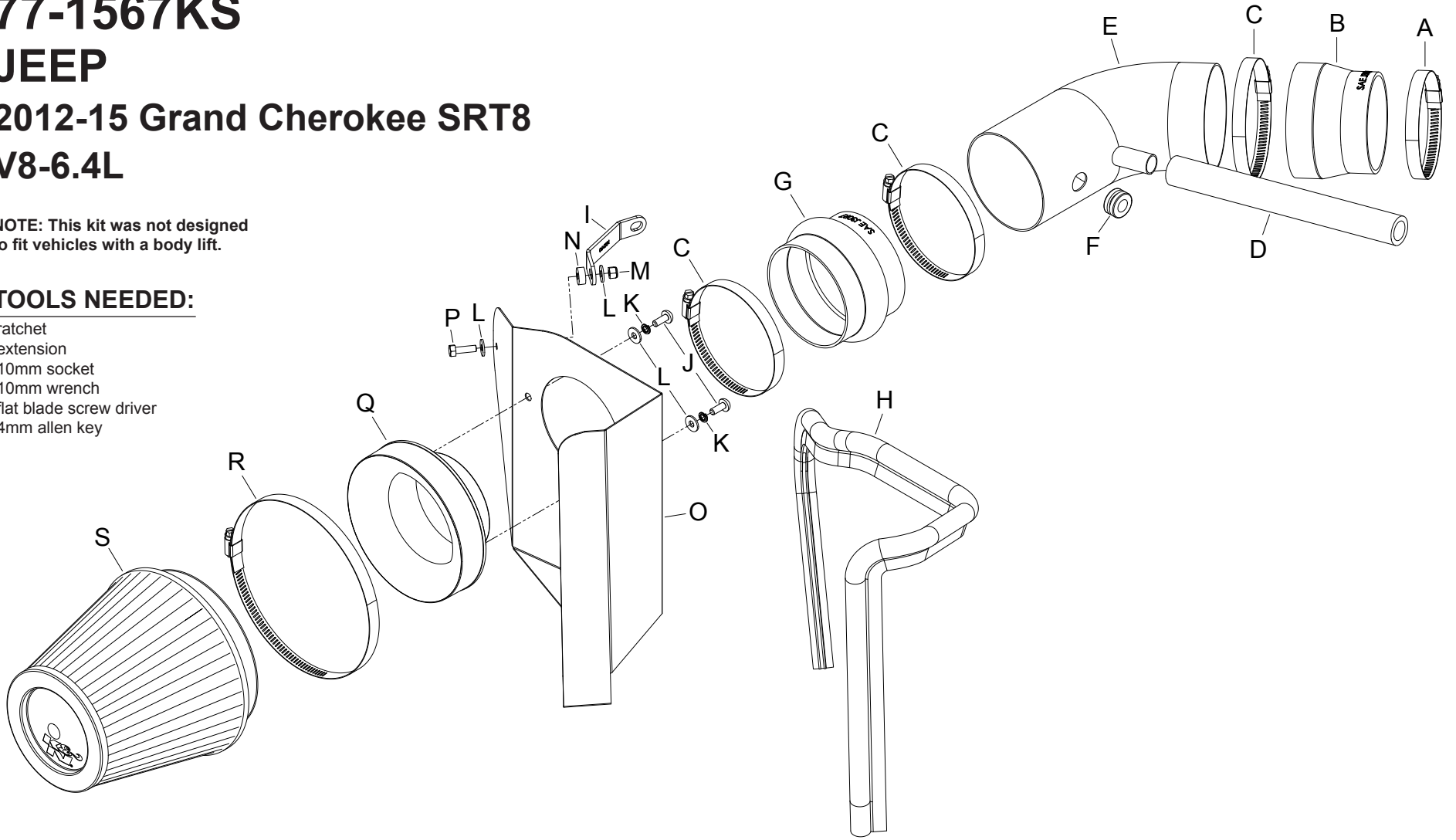

PARTS LIST:

Description	Qty.	Part #	Description	Qty.	Part #	Description	Qty.	Part #
A hose clamp #56	1	08620	H edge trim (39")	1	102496	O heat shield	1	073191
B hose; 4" id to 3.5" id x 3" l tprd	1	08497	I bracket; "c", 77-1567, stl, tb/pc	1	064331	P bolt; m6 x 1.00" x 20mm hex, ss	1	07795
C hose clamp #64 stainless	3	08645	J bolt; m6 x 1.00 x 16mm, ss	2	07730	Q adaptor; 57-3058 #454	1	27300
D hose; 3/4" id x 10" l	1	5-4010	K washer, m6 split lock zinc	2	1-3025	R hose clamp # 104	1	08697
E intake tube	1	27566	L washer; 6mm flat, ss	4	08269	S air filter	1	RF-1042
F grommet; 1" od, 1/2" id, 1/2" thk	1	08064	M nut; 6mm nylock, hexhead, ss	1	07512			
G hose; 4" id x 3" l hump reinforced	1	08418	N spacer: .625" od x .250" id x .250" l	1	06555			

NOTE: FAILURE TO FOLLOW INSTALLATION INSTRUCTIONS AND NOT USING THE PROVIDED HARDWARE MAY DAMAGE THE INTAKE TUBE, THROTTLE BODY AND ENGINE.

TO START:

1. Turn off the ignition and disconnect the negative battery cable.
NOTE: Disconnecting the negative battery cable erases pre-programmed electronic memories. Write down all memory settings before disconnecting the negative battery cable. Some radios will require an anti-theft code to be entered after the battery is reconnected. The anti-theft code is typically supplied with your owner's manual. In the event your vehicles anti-theft code cannot be recovered, contact an authorized dealership to obtain your vehicles anti-theft code.

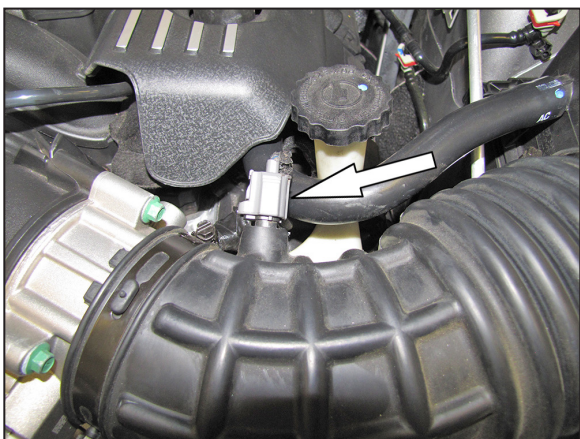

2. Disconnect the inlet air temperature air sensor electrical connection.



3. Remove the driver's side decorative engine cover.



4. Disconnect the crank case vent hose from the valve cover port.

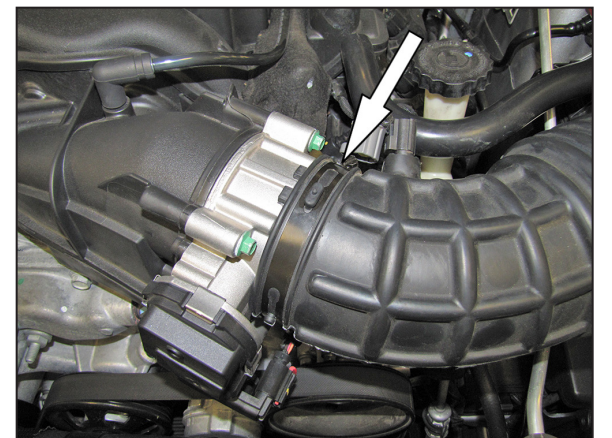

5. Loosen the hose clamp securing the factory intake tube to the throttle body.



6. Lift up the air filter assembly to dislodge it from the mounting grommets and the remove the complete assembly from the vehicle.
NOTE: K&N Engineering, Inc., recommends that customers do not discard factory air intake.

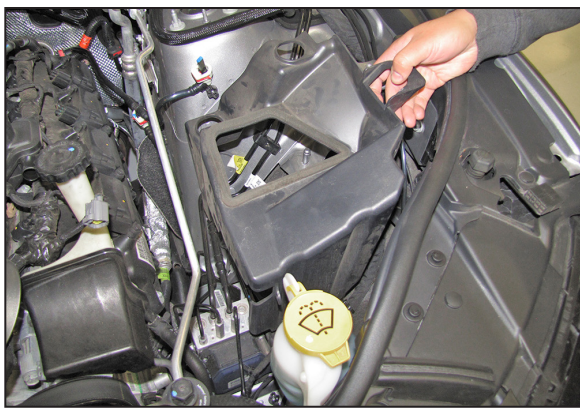

7. Lift out and remove the inlet air diverter tray from the vehicle.

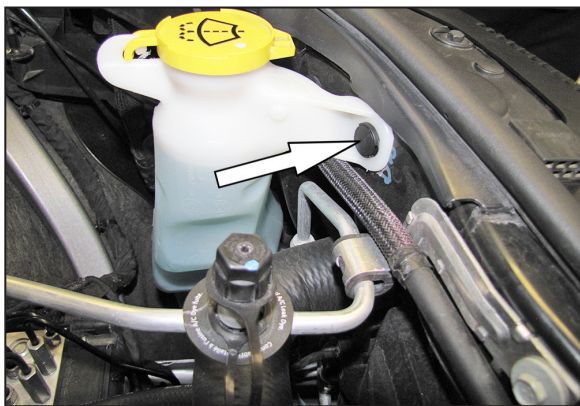

8. Remove the retaining clip that secures the windshield washer bottle to the core support. **NOTE: The retaining clip will be reused in a later step.**

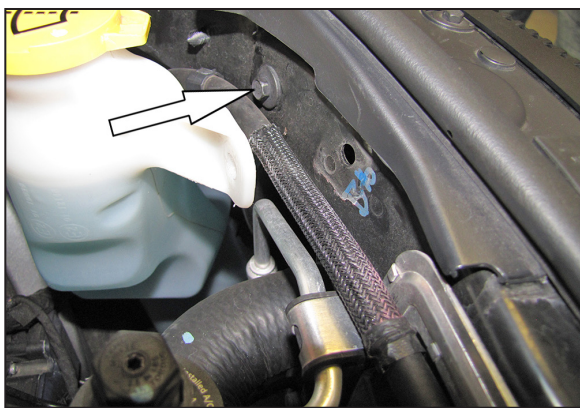

9. Remove the core support bolt shown. **NOTE: This bolt will be reused in the next step.**

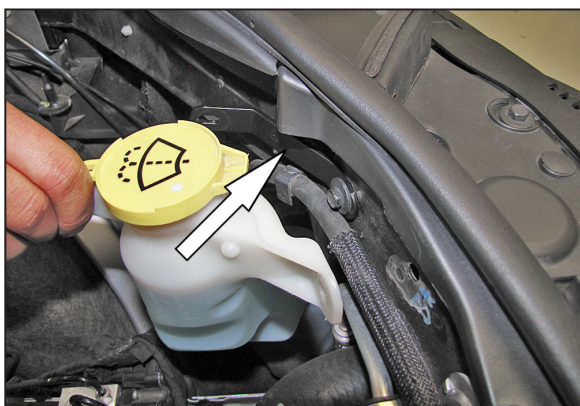

10. Install the provided heat shield mounting bracket onto the core support and secure with the factory bolt from the previous step.



11. Secure the windshield washer bottle to the core support using the factory retaining clip from step #8.

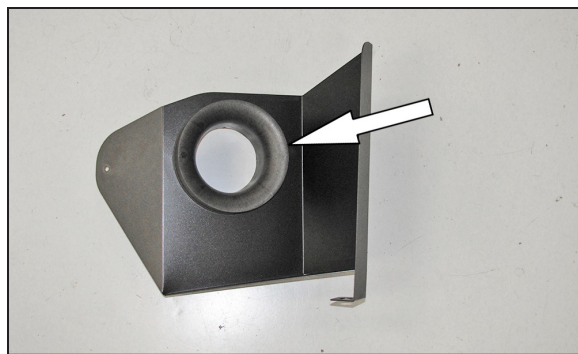

12. Install the filter adapter into the heat shield and secure with the provided hardware.

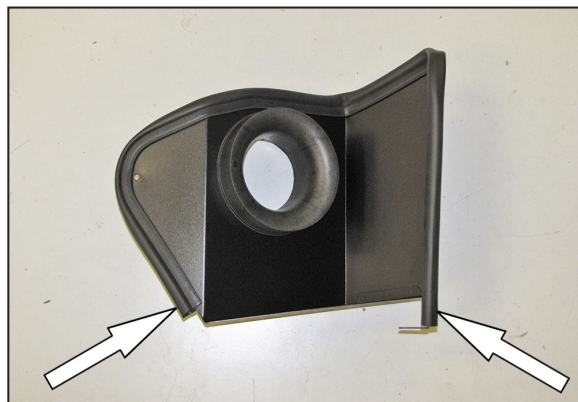

13. Install the edge trim onto the heat shield as shown. **NOTE: Some trimming of the edge trim will be necessary.**

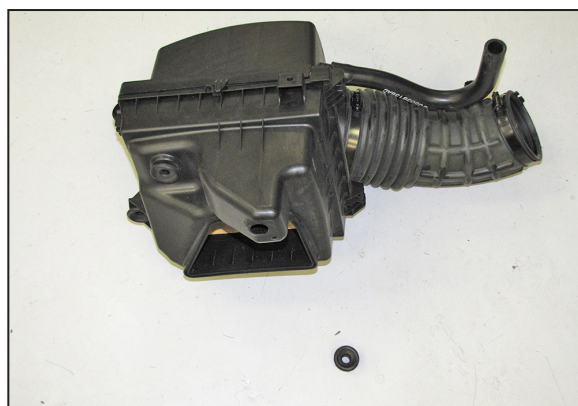

14. Remove one of the factory mounting grommets from the air filter housing assembly as shown.

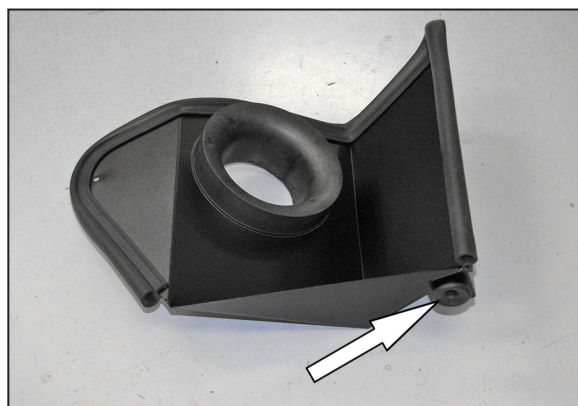

15. Install the factory mounting grommet into the heat shield as shown.



16. Install the heat shield assembly into the vehicle so the mounting grommet slides onto the inner most mounting stud. Align the heat shield with the mounting bracket and then secure with the spacer and hardware provided. **NOTE: Be sure to place the spacer between the bracket and heat shield.**

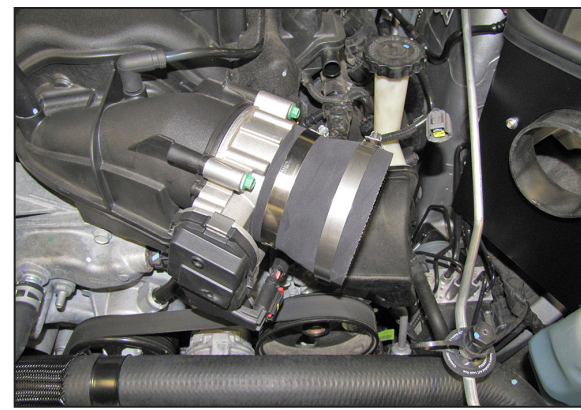

17. Install the step coupler (08497) onto the throttle body and secure with the provided hose clamp.

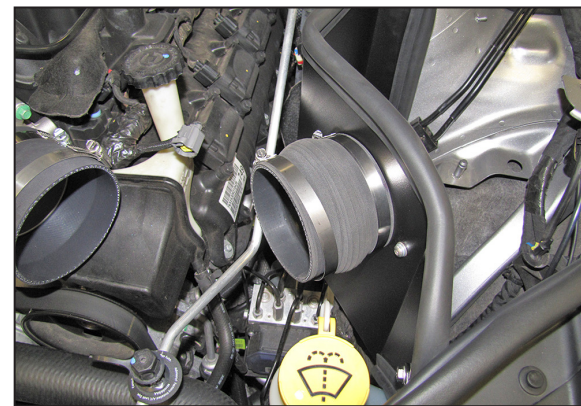

18. Install the provided coupler (08418) onto the filter adapter and secure with the provided hose clamp.

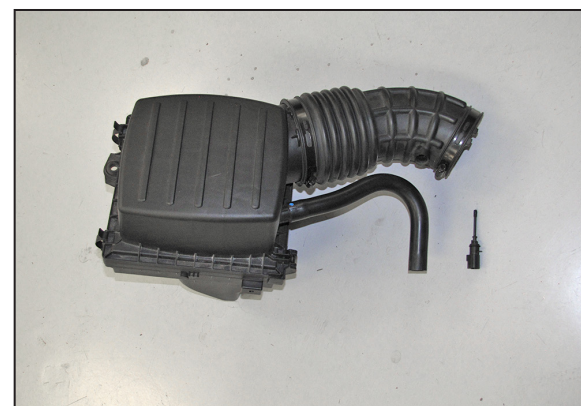

19. Remove the inlet air temperature sensor from the factory intake tube.

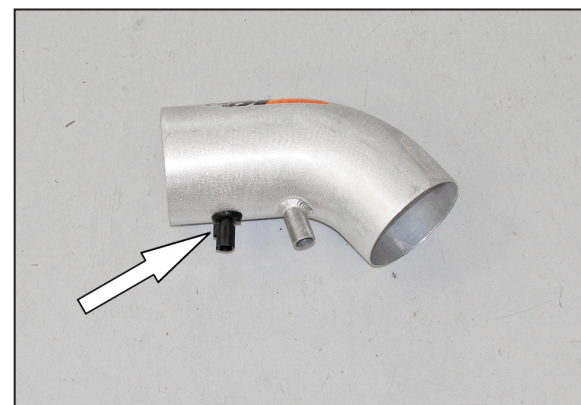

20. Install the provided grommet into the K&N® intake tube. Remove the O-ring from the inlet air temperature sensor and then install the sensor into the grommet as shown.



21. Install the K&N® intake tube into the hump coupler and then into the straight coupler, adjust the intake tube for best fit and then secure with the provided hose clamps.

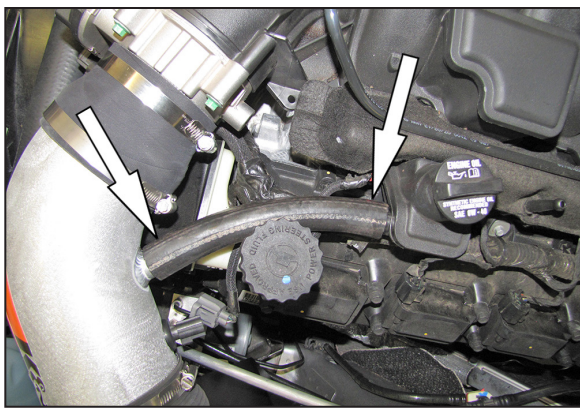

22. Install the provided crank case vent hose onto the valve cover port and then to the port on the K&N® intake tube.

NOTE: Some trimming of the hose may be necessary.

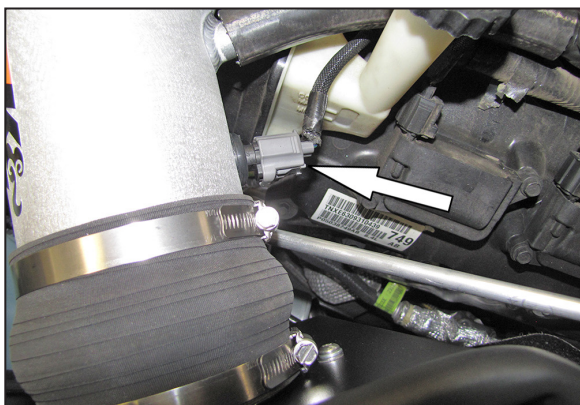

23. Reconnect the inlet air temperature sensor electrical connection.



24. Reinstall the driver's side decorative engine cover.

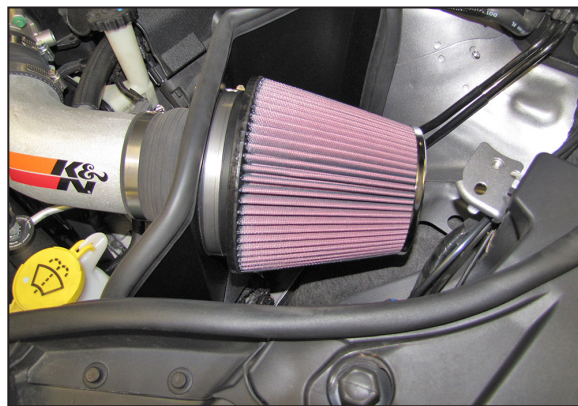

25. Install the K&N® air filter and secure with the provided hose clamp.

NOTE: Drycharger® air filter wrap; part # RF-1042DK is available to purchase separately. To learn more about Drycharger® filter wraps or look up color availability please visit <http://www.knfilters.com>®.



26. Reconnect the vehicle's negative battery cable. Double check to make sure everything is tight and properly positioned before starting the vehicle.

27. It will be necessary for all K&N® high flow intake systems to be checked periodically for realignment, clearance and tightening of all connections. Failure to follow the above instructions or proper maintenance may void warranty.

ROAD TESTING:

1. Start the engine with the transmission in neutral or park, and the parking brake engaged. Listen for air leaks or odd noises. For air leaks secure hoses and connections. For odd noises, find cause and repair before proceeding. This kit will function identically to the factory system except for being louder and much more responsive.

2. Test drive the vehicle. Listen for odd noises or rattles and fix as necessary.

3. If road test is fine, you can now enjoy the added power and performance from your kit.

4. K&N Engineering, Inc., requires cleaning the intake system's air filter element every 100,000 miles. When used in dusty or off-road environments, our filters will require cleaning more often. We recommend that you visually inspect your filter once every 25,000 miles to determine if the screen is still visible. When the screen is no longer visible some place on the filter element, it is time to clean it. To clean and re-oil, purchase our filter Recharger® service kit, part number 99-5050 or 99-5000 and follow the easy instructions.

NOT LEGAL FOR SALE OR USE ON ANY POLLUTION CONTROLLED MOTOR VEHICLE IN CALIFORNIA OR STATES ADOPTING CALIFORNIA EMISSION PROCEDURES.

See knfilters.com for CARB status on each part for a specific vehicle